

Saw Hand

Item Number	Standard			Metric		
	Length (l)	Size (h)	Weight	Length (l)	Size (h)	Weight
927-2A1-02A	27 1/2"	1 3/8"	1.146	700 mm	35 mm	0.520

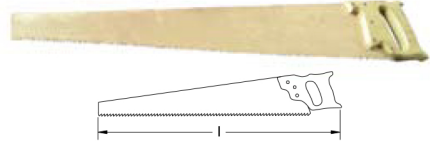

Saw Hack - Jig

Item Number	Standard			Metric		
	Length (l)	Size (h)	Weight	Length (l)	Size (h)	Weight
927-210-02A	14 1/2"	4 1/2"	0.584	370 mm	114 mm	0.265

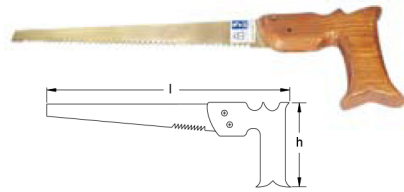

Saw Hack - Frame

Item Number	Standard			Metric		
	Length (l)	Height (h)	Weight	Length (l)	Height (h)	Weight
927-010-02B	20"	-	1.301	500 mm	110 mm	0.590

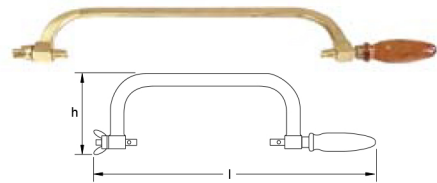

Saw Hack - Blade

Item Number	Standard		Metric	
	Length (l)	Weight	Length (l)	Weight
927-110-02B	12"	0.071	300 mm	0.032



Pipe Cutter

Item Number	Standard		Metric	
	Capacity (d)	Weight	Capacity (d)	Weight
930-510-02A	2"	4.431	50 mm	2.010

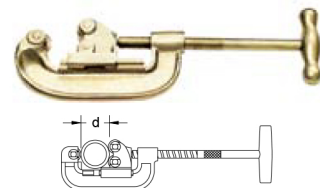

Clamp C- Type

Item Number	Standard				Metric			
	Length (l)	Opening (a)	Throat (b)	Weight	Length (l)	Opening (a)	Throat (b)	Weight
927-4A1-02A	3"	3/4"	3/4"	0.397	76 mm	19 mm	19 mm	0.180
927-4A1-04A	11 3/8"	4 1/2"	3"	11.024	290 mm	115 mm	75 mm	5.000
927-4A1-06A	14 1/2"	6 1/2"	3 1/2"	22.047	370 mm	165 mm	90 mm	10.000

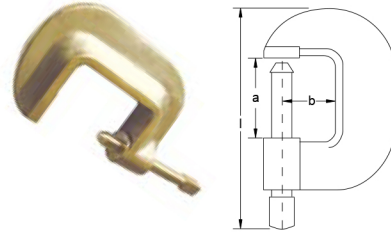

Sliding Clamp (Bar)

Item Number	Standard			Metric		
	Length (k)	Depth (b)	Weight	Length (k)	Depth (b)	Weight
929-510-02A	16"	4 3/4"	4.850	400 mm	120 mm	2.200

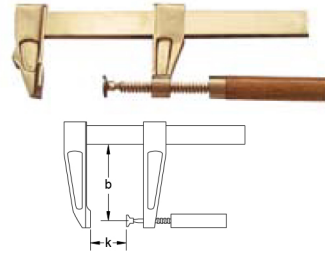

Parallel Vise - Swivel Base

Item Number	Standard		Metric	
	Capacity (c)	Weight	Capacity (c)	Weight
931-110-02A	3 1/2"	16.315	90 mm	7.400
931-110-04A	5"	37.039	125 mm	16.800
931-110-06A	6"	58.425	150 mm	26.500

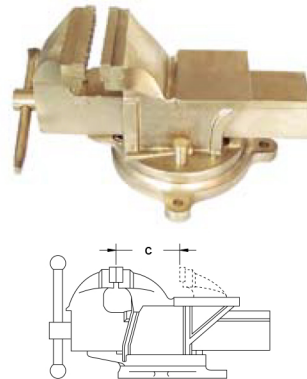

Flange Spreader

Item Number	Standard		Metric	
	Capacity	Weight	Capacity	Weight
931-010-02A	5/8" - 15/16"	14.551 lbs	16 mm - 24 mm	6.600 kg
931-010-04A	1 1/16" - 1 13/32"	19.842 lbs	27 mm - 36 mm	9.000 kg



Gear Puller 3 Legged

Item Number	Standard		Metric	
	Capacity	Weight	Capacity	Weight
927-310-02A	4" cap	6.594	100 mm cap	2.991
927-310-04A	6" cap	8.102	150 mm cap	3.675
927-310-06A	8" cap	11.976	200 mm cap	5.432
927-310-08A	14" cap	24.761	350 mm cap	11.231



Chain Hoist

Item Number	Standard			Metric		
	Lift	Capacity	Weight	Lift	Capacity	Weight
930-810-04A	8'	2200 lbs	29.984	2.5 m	1 ton	13.600
930-810-06A	8'	4400 lbs	48.504	2.5 m	2 ton	22.000

Other Sizes Available Upon Request



Pump Manual Portable

Item Number	Standard		Metric	
	Length (l)	Weight	Length (l)	Weight
929-310-02A	54"	11.024	1350 mm	5.000

